

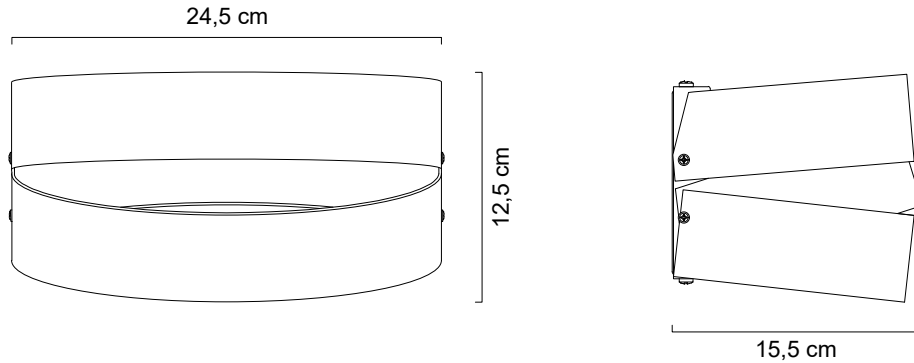



10025966

1x E14 LED max. 10W
230V ~ 50Hz



(DE) Bestimmungsgemäße Verwendung (GB) Intended use / (FR) Utilisation conforme / (NL) Beoogd gebruik / (PL) Stosowanie zgodnie z przeznaczeniem / (NO) Riktig bruk / (DK) Korrekt brug / (SE) Avsedd användning / (FI) Määräystenmukainen käyttö (IT) Impiego appropriato / (ES) Uso prescrito / (CZ) Použití v souladu s určením / (PT) Utilização correta / (GR) Ενδεικνυμένη χρήση	
(DE) Ortsfeste Verwendung als Wandleuchte im Innenbereich	(GB) Provided for stationary indoor use on the wall
(FR) Installation fixe en tant que Applique à l'intérieur	(NL) Vast gebruik als wandlamp binnenshuis
(PL) Do montażu stacjonarnego jako lampa ścienna do wnętrza	(NO) Til stasjonært bruk som vegg lampe innendørs
(DK) Til stationær brug som væglampe indendørs	(SE) Används som fast vägg lamp a inomhus
(FI) Kiinteä käyttö sisätilojen seinävalaistuksena	(IT) Impiego fisso come lampada a muro in ambienti interni
(ES) Empleo fijo como lámpara de pared en interiores	(CZ) Stacionární použití jako nástěnná lampa v interiéru
(PT) Aplicação fixa como lâmpada de parede em interiores	(GR) Σταθερή χρήση ως φωτιστικό τοίχου σε εσωτερικό χώρο

(DE) Verwendete Symbole (GB) Safety Precautions / (FR) Symboles utilisés / (NL) Gebruikte symbolen / (PL) Stosowane symbole / (NO) Brukte symboler / (DK) Brugte symboler / (SE) Använda symboler / (FI) Käytetyt symbolit / (IT) Simboli usati / (ES) Símbolos empleados / (CZ) Použité symboly / (PT) Símbolos utilizados / (GR) Χρησιμοποιούμενα σύμβολα	
IP 20	   

(DE) Lieferumfang (GB) Package contents / (FR) Contenu de la livraison / (NL) Bij de levering inbegrepen / (PL) Zakres dostawy / (NO) Leveringsomfang / (DK) Leveringsomfang / (SE) Leveransomfattning / (FI) Toimitussisältö / (IT) Fornitura / (ES) Volumen de suministro / (CZ) Rozsah dodávky / (PT) Material fornecido / (GR) Παραδοτέος εξοπλισμός			
(DE) 1 Wandleuchte Montagematerial Montageanleitung	(GB) 1 Wall lamp Installation hardware Mounting instructions	(FR) 1 Applique Matériel de montage Instructions de montage	
(NL) 1 Wandlamp Monteringsmateriale Montagehandleiding	(PL) 1 Lampa ścienna Elementy montażowe Instrukcja montażu	(NO) 1 Vegg lampe Monteringsmateriale Brukerveiledning	
(DK) 1 Væglampe Monteringsmateriale Brugervejledning	(SE) 1 Vägg lamp a Monteringsmaterial Monteringsanvisning	(FI) 1 Seinä lamp pu Asennus materiaali Asennusohjeet	
(IT) 1 Lampada a muro Materiale di montaggio Istruzioni di montaggio	(ES) 1 Lámpara de pared Material de montaje Instrucciones de montaje	(CZ) 1 Nástěnná lampa Materiál pro montáž Návod k montáži	
(PT) 1 Lámpada de parede Material de montagem Instruções de montagem	(GR) 1 λάμπα τοίχου Υλικά συναρμολόγησης Οδηγίες συναρμολόγησης		

EULUNA

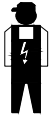

Instrukcja montażu / Installation instructions / Montageanleitung

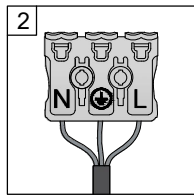
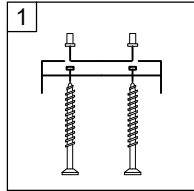
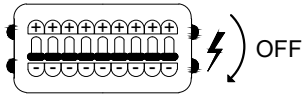

1

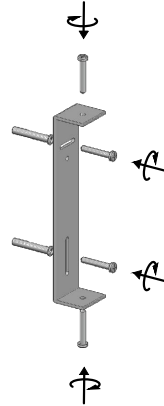

2

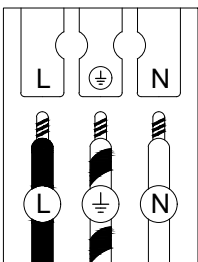
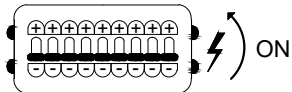
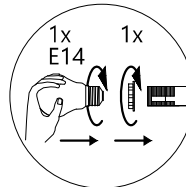
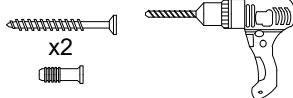
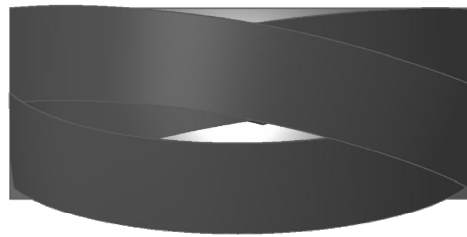

	(DE)	(GB)	(FR)	(NL)	(PL)	(NO)	(DK)
L	Stromführender Leiter	Live conductor	Conducteur	Spanningvoerende draad	Przewód prądowy	Strømførende leder	Strømførende leder
	Schutzleiter	Earth conductor	Conducteur de protection (terre)	Aardkabel	Przewód uziemiający	Jordledningen	Jordledningen
N	Neutralleiter	Neutral conductor	Conducteur neutre	Nulleider	Przewód zerowy	Nøytralleider	Neutralleider

	(SE)	(FI)	(IT)	(ES)	(CZ)	(PT)	(GR)
L	Strömförande ledare	Virtajohdin	Conduttore sotto tensione	Conductor de corriente	Vodič pod napětím	Condutor vivo	Ρευματοφόρος αγωγός
	Skyddsledare	Suojajohdin	Conduttore di terra	Conductor de protección	Ochranný vodič	Condutor de terra	Αγωγός γείωσης
N	Neutralledare	Nollajohdin	Conduttore neutro	Conductor neutro	Neutrální vodič	Condutor neutro	Ουδέτερος αγωγός